

0 607 351 105

Issue } 04-08-03
Stand } **Fig./Abb. 1**

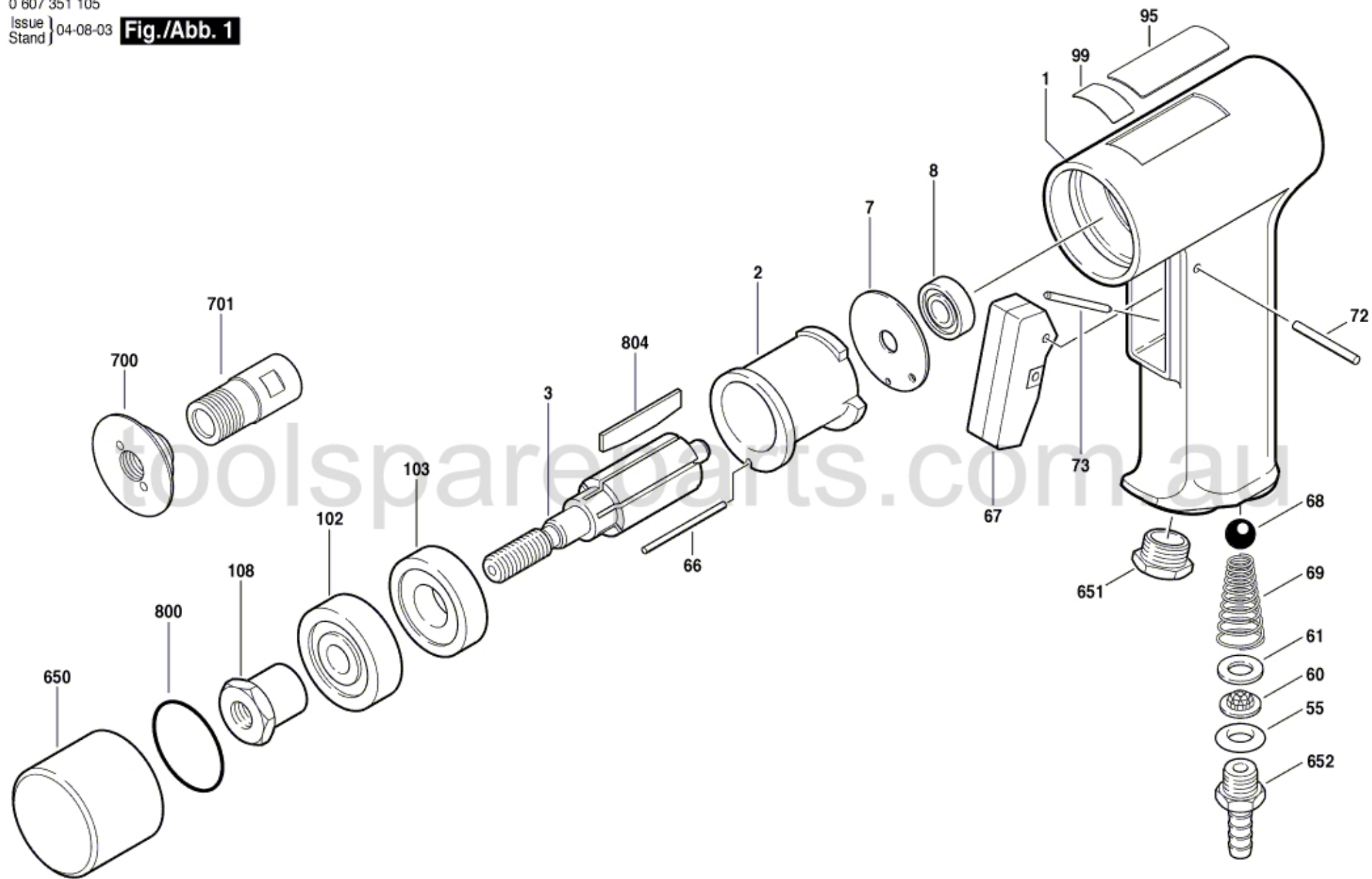

Modifications reserved
Änderungen vorbehalten
Modifications réservées
Salvo modificaciones